

furo Brushed Gold KDD

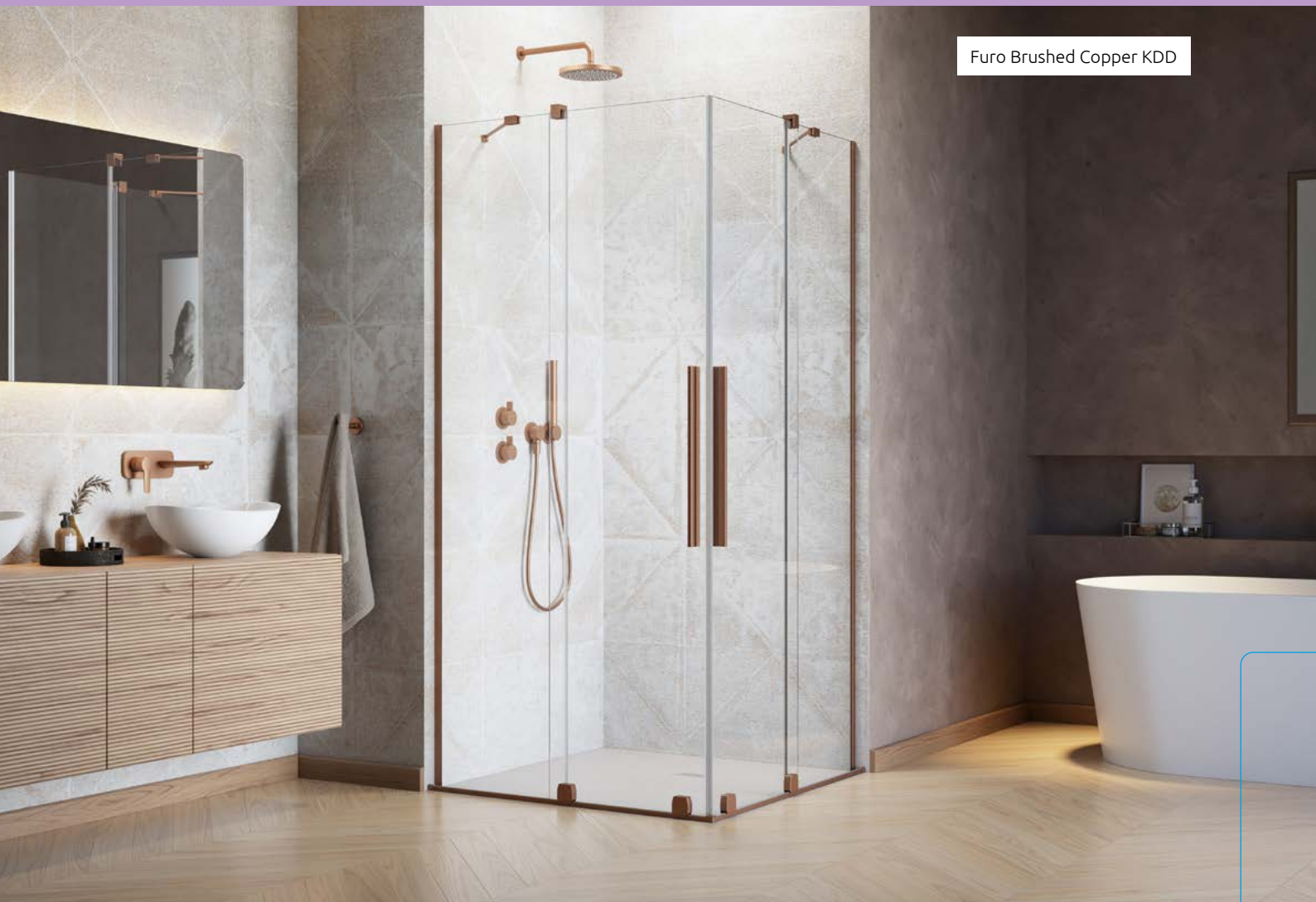

furo Brushed GunMetal KDD



Furo Brushed Copper KDD



Furo Brushed Nickel KDD

Furo KDD

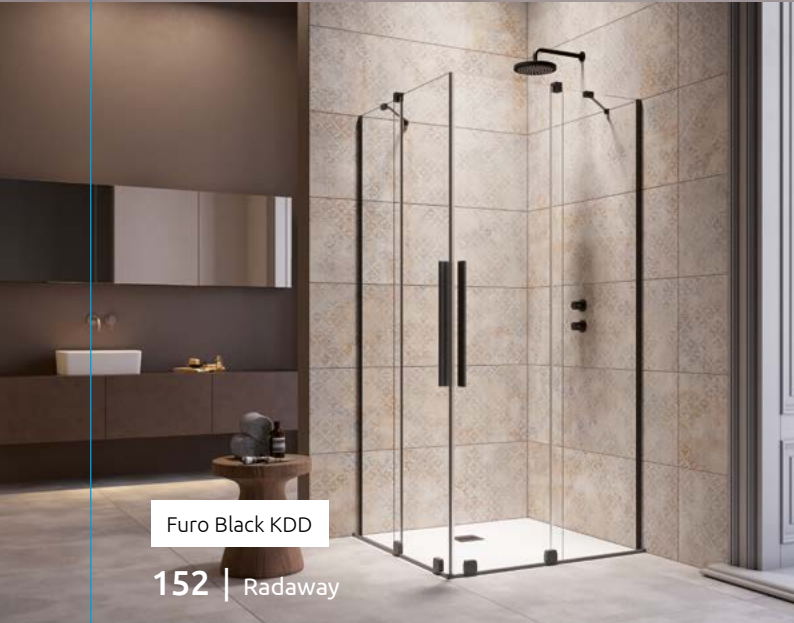
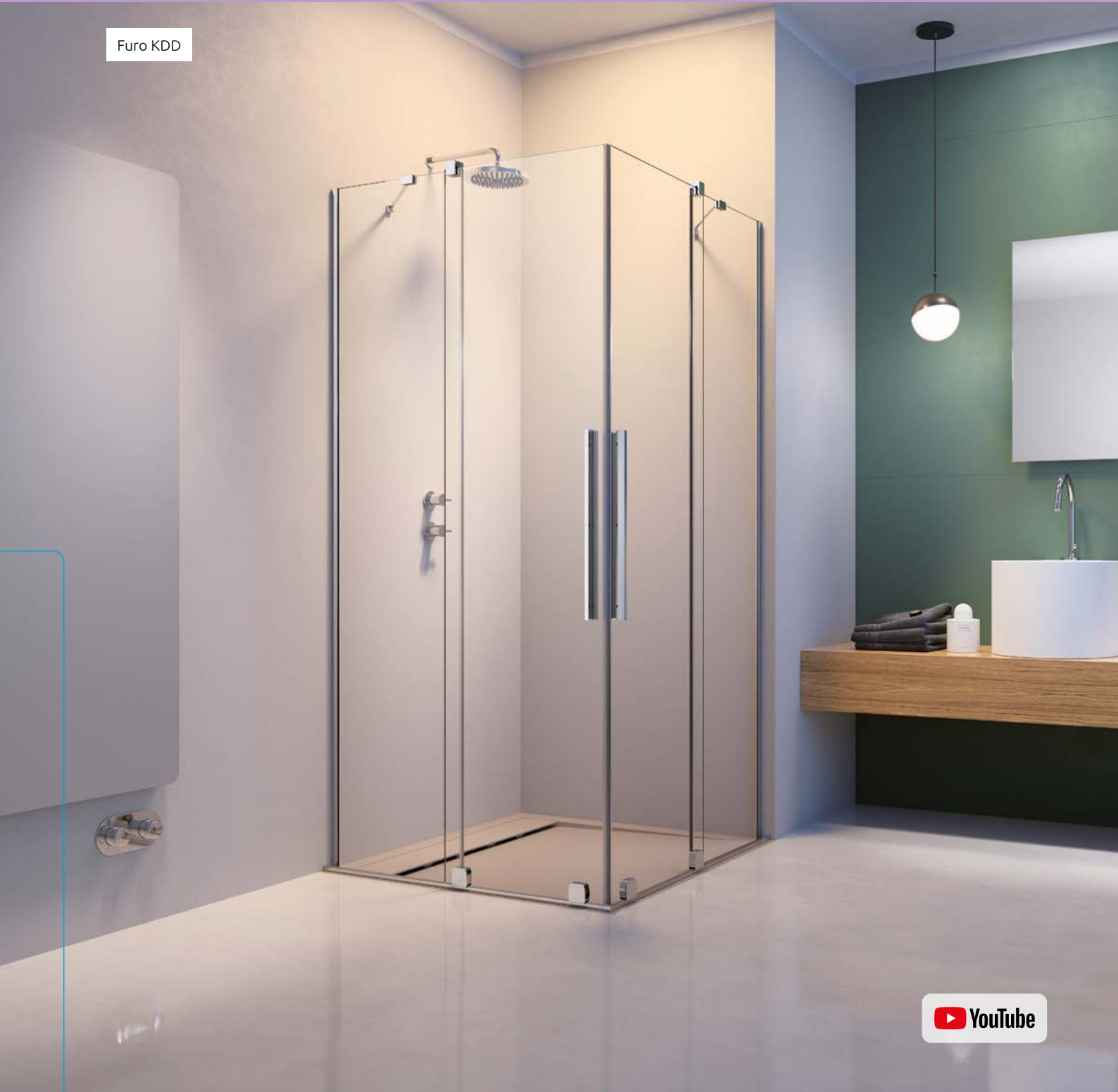

Furo Black KDD



Furo Gold KDD

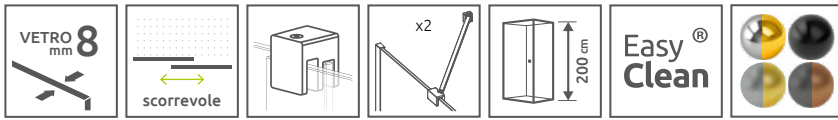

	Chrome	01
	Gold	09
	Black	54
	Brushed Nickel	91
	Brushed GunMetal	92
	Brushed Copper	93
	Brushed Gold	99

OPZIONI AGGIUNTIVE

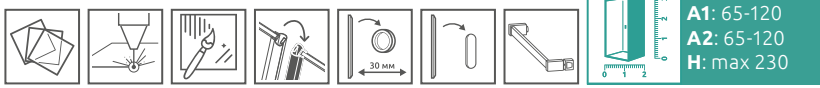

Prezzo su misura, pag. 8

2 CODICI ARTICOLO:  
PARTE SINISTRA + PARTE DESTRA

Sostituire **XX** con il **codice del colore**

PREZZO SOLO DI 1 PARTE: SINISTRA O DESTRA

Modello	Piatto doccia A1 o A2	Box doccia X1 o X2	N. art. PARTE SINISTRA	N. art. PARTE DESTRA	PREZZO		
					Cromo	Nero	Altri
80	78-79	77-78	S-10105080-XX-01L	S-10105080-XX-01R			
90	88-89	87-88	S-10105090-XX-01L	S-10105090-XX-01R			
100	98-99	97-98	S-10105100-XX-01L	S-10105100-XX-01R			
110	108-109	107-108	S-10105110-XX-01L	S-10105110-XX-01R			
120	118-119	117-118	S-10105120-XX-01L	S-10105120-XX-01R			

DETTAGLI

Configurazione quadrata	Apertura D	Configurazione rettangolare	Apertura D	Configurazione rettangolare	Apertura D
80 x 80	≈ 42	80 x 90	≈ 46	90 x 110	≈ 57
90 x 90	≈ 49	80 x 100	≈ 50	90 x 120	≈ 61
100 x 100	≈ 56	80 x 110	≈ 54	100 x 110	≈ 60
110 x 110	≈ 63	80 x 120	≈ 58	100 x 120	≈ 64
120 x 120	≈ 71	90 x 100	≈ 53	110 x 120	≈ 67

Se il tuo piatto doccia (A1/A2) dopo l'installazione misura 80, 90, 100... come nella colonna „Modello”, è possibile ordinare questo prodotto con lo stesso prezzo. Chiedi maggiori informazioni.

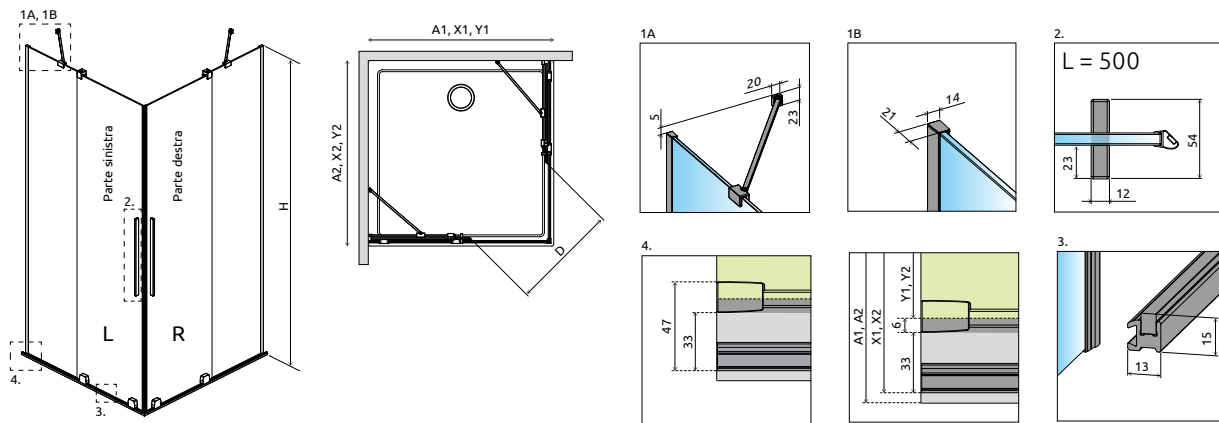

Y1 = X1 - 39 mm  
Y2 = X2 - 39 mm

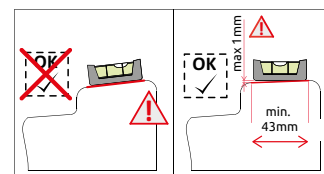

NAVIGAZIONE: ANGOLARE – SCORREVOLE

