

Essenza Pro PTJ

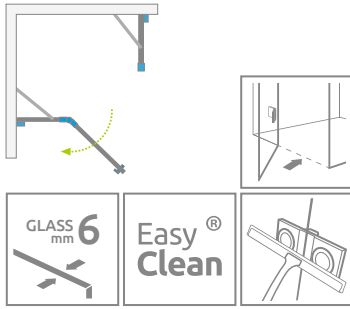

Profile finish:

Glossy:

Matte:

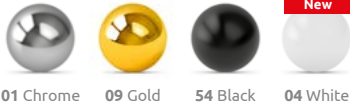

Brushed:



The product in other colour variants can be found on p. 220

Instruction for ordering the Essenza Pro PTJ shower enclosure can be found on page 588.

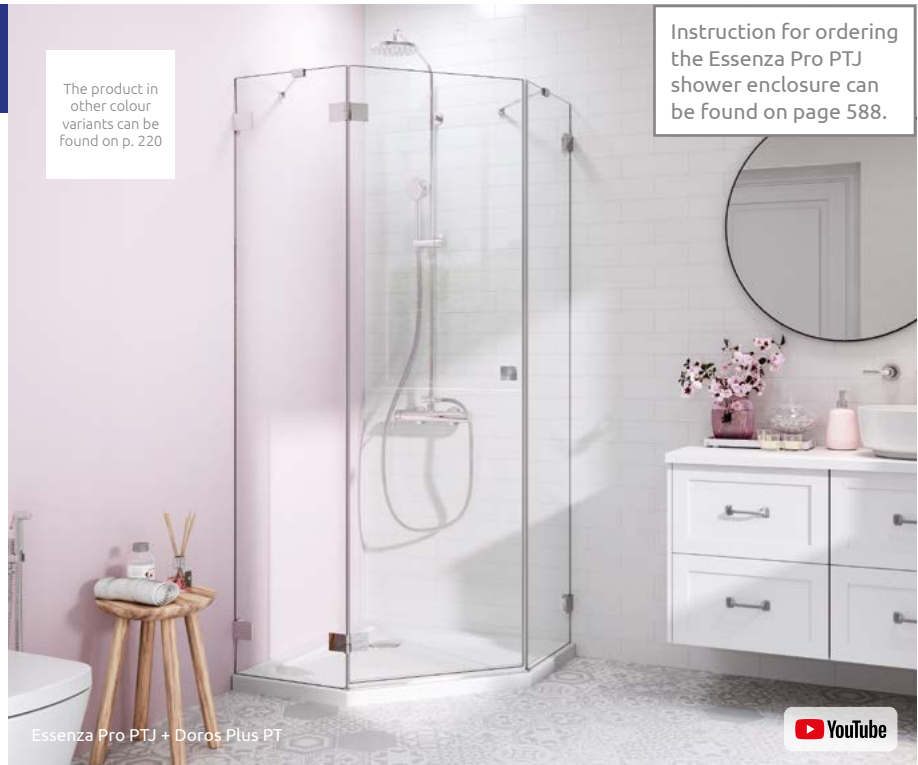

Essenza Pro PTJ + Doros Plus PT



Shower enclosure set consists of 2 parts: shower door and sidewalls Z and S. Please specify all the article numbers when making an order.

SYMMETRIC SHOWER ENCLOSURES

In the article number, the symbol "XX" should be replaced with the symbol of the selected colour: 04, 54

In the article number, the symbol "XX" should be replaced with the symbol of the selected colour: 09, 91, 92, 93, 99

Model	Element	TRANSPARENT GLASS		
		profile finish: CHROME Art. No.	Art. No.	Art. No.
PTJ 80×80 door L	PTJ door L	10100000-01-01L	10100000-XX-01L	10100000-XX-01L
	PTJ walls 80 Z×80 S	10100100-01-01	10100100-01-01	10100100-01-01
PTJ 80×80 door R	PTJ door R	10100000-01-01R	10100000-XX-01R	10100000-XX-01R
	PTJ walls 80 Z×80 S	10100100-01-01	10100100-01-01	10100100-01-01
PTJ 90×90 door L	PTJ door L	10100000-01-01L	10100000-XX-01L	10100000-XX-01L
	PTJ walls 90 Z×90 S	10100200-01-01	10100200-01-01	10100200-01-01
PTJ 90×90 door R	PTJ door R	10100000-01-01R	10100000-XX-01R	10100000-XX-01R
	PTJ walls 90 Z×90 S	10100200-01-01	10100200-01-01	10100200-01-01
PTJ 100×100 door L	PTJ door L	10100000-01-01L	10100000-XX-01L	10100000-XX-01L
	PTJ walls 100 Z×100 S	10100300-01-01	10100300-01-01	10100300-01-01
PTJ 100×100 door R	PTJ door R	10100000-01-01R	10100000-XX-01R	10100000-XX-01R
	PTJ walls 100 Z×100 S	10100300-01-01	10100300-01-01	10100300-01-01

ASYMMETRIC SHOWER ENCLOSURES

Instructions for ordering the Essenza PTJ shower enclosure can be found on page 588.

In the article number, the symbol "XX" should be replaced with the symbol of the selected colour: 04, 54

In the article number, the symbol "XX" should be replaced with the symbol of the selected colour: 09, 91, 92, 93, 99

Model	Element	TRANSPARENT GLASS		
		profile finish: CHROME Art. No.	Art. No.	Art. No.
PTJ 80×90 door L on shorter side*	PTJ door L	10100000-01-01L	10100000-XX-01L	10100000-XX-01L
	PTJ walls 80 Z×90 S	10100400-01-01	10100400-01-01	10100400-01-01
PTJ 80×90 door R on shorter side*	PTJ door R	10100000-01-01R	10100000-XX-01R	10100000-XX-01R
	PTJ walls 80 Z×90 S	10100400-01-01	10100400-01-01	10100400-01-01
PTJ 90×80 door L on longer side*	PTJ door L	10100000-01-01L	10100000-XX-01L	10100000-XX-01L
	PTJ walls 90 Z×80 S	10100600-01-01	10100600-01-01	10100600-01-01
PTJ 90×80 door R on longer side*	PTJ door R	10100000-01-01R	10100000-XX-01R	10100000-XX-01R
	PTJ walls 90 Z×80 S	10100600-01-01	10100600-01-01	10100600-01-01
PTJ 80×100 door L on shorter side	PTJ door L	10100000-01-01L	10100000-XX-01L	10100000-XX-01L
	PTJ walls 80 Z×100 S	10100500-01-01	10100500-01-01	10100500-01-01
PTJ 80×100 door R on shorter side	PTJ door R	10100000-01-01R	10100000-XX-01R	10100000-XX-01R
	PTJ walls 80 Z×100 S	10100500-01-01	10100500-01-01	10100500-01-01
PTJ 100×80 door L on longer side	PTJ door L	10100000-01-01L	10100000-XX-01L	10100000-XX-01L
	PTJ walls 100 Z×80 S	10100800-01-01	10100800-01-01	10100800-01-01
PTJ 100×80 door R on longer side	PTJ door R	10100000-01-01R	10100000-XX-01R	10100000-XX-01R
	PTJ walls 100 Z×80 S	10100800-01-01	10100800-01-01	10100800-01-01
PTJ 90×100 door L on shorter side	PTJ door L	10100000-01-01L	10100000-XX-01L	10100000-XX-01L
	PTJ walls 90 Z×100 S	10100700-01-01	10100700-01-01	10100700-01-01
PTJ 90×100 door R on shorter side	PTJ door R	10100000-01-01R	10100000-XX-01R	10100000-XX-01R
	PTJ walls 90 Z×100 S	10100700-01-01	10100700-01-01	10100700-01-01
PTJ 100×90 door L on longer side	PTJ door L	10100000-01-01L	10100000-XX-01L	10100000-XX-01L
	PTJ walls 100 Z×90 S	10100900-01-01	10100900-01-01	10100900-01-01
PTJ 100×90 door R on longer side	PTJ door R	10100000-01-01R	10100000-XX-01R	10100000-XX-01R
	PTJ walls 100 Z×90 S	10100900-01-01	10100900-01-01	10100900-01-01

* Only shower boards are available for selected models.

TECHNICAL DRAWINGS

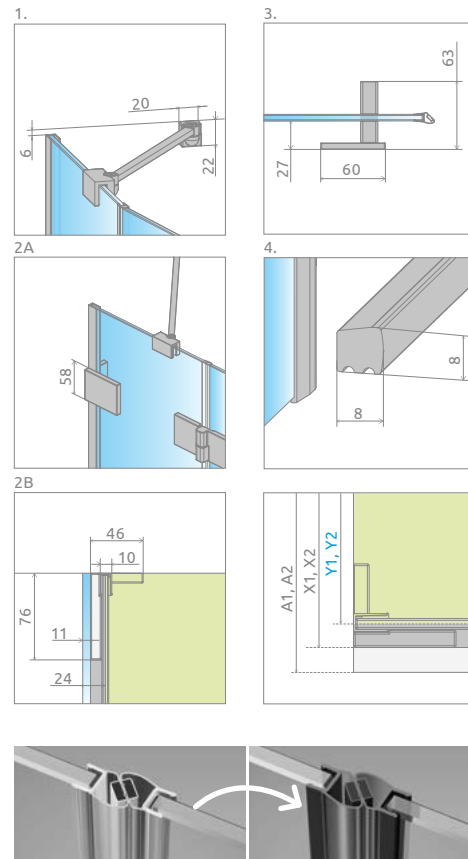
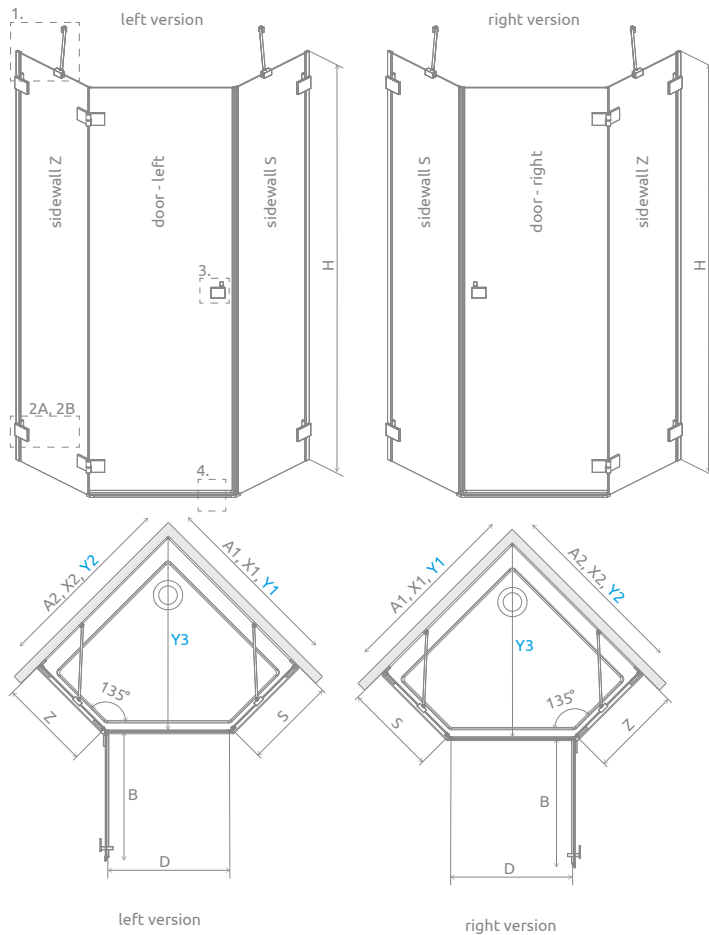

There is a possibility of a paid replacement of transparent gaskets for black gaskets:

- option no. 1 – only magnetic gaskets,
 - option no. 2 – all gaskets (magnetic, vertical and horizontal).
- The selected option must be clearly stated in the order.

Model	A1	A2	X1	X2	Y1	Y2	Y3	B	Z	S	D	H
PTJ 80Z×80S	800	800	789-797	789-797	776-784	776-784	788-799	638	345-353	340-348	600	2000
PTJ 90Z×90S	900	900	889-897	889-897	876-884	876-884	930-941	638	445-453	440-448	600	2000
PTJ 100Z×100S	1000	1000	989-997	989-997	976-984	976-984	1071-1082	638	545-553	540-548	600	2000
PTJ 80Z×90S	800	900	789-797	889-897	776-784	876-884	859-870	638	345-353	440-448	600	2000
PTJ 80Z×100S	800	1000	789-797	989-997	776-784	976-984	930-941	638	345-353	540-548	600	2000
PTJ 90Z×80S	900	800	889-897	789-797	876-884	776-784	859-870	638	445-453	340-348	600	2000
PTJ 90Z×100S	900	1000	889-897	989-997	876-884	976-984	1000-1011	638	445-453	540-548	600	2000
PTJ 100Z×80S	1000	800	989-997	789-797	976-984	776-784	930-941	638	545-553	340-348	600	2000
PTJ 100Z×90S	1000	900	989-997	889-897	976-984	876-884	1000-1011	638	545-553	440-448	600	2000

The table of dimensions for installation without a shower tray is available at radaway.eu

ADDITIONAL OPTIONS

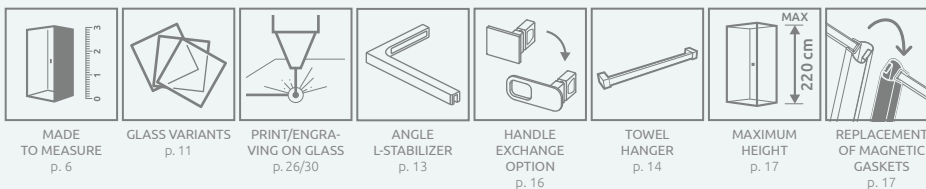

NAVIGATION

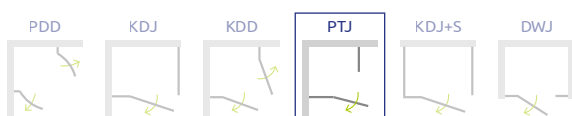

Dimensions are given in mm.