

CUSTOMER DATA: _____
 SERIES AND MODEL: _____ INSTALLER DATA: _____
 FITTINGS COLOR: _____
 GLASS COLOR: _____

MOUNTING PROFILE:	X	Y
COMPLIES WITH SERIES AND MODELS	<input type="checkbox"/>	<input type="checkbox"/>
OTHER:	<input type="checkbox"/>	<input type="checkbox"/>
OTHER:	<input type="checkbox"/>	<input type="checkbox"/>

MEASUREMENT METHODS: ENTRANCE SIDE „X” SIDE „Y”

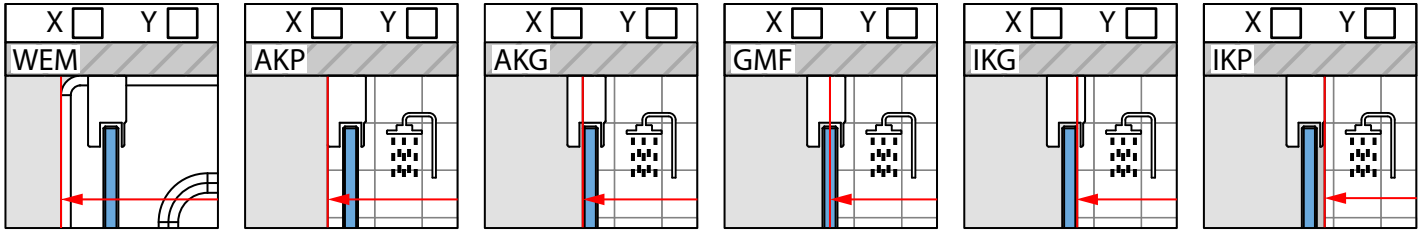

MAIN DRAWING

CONSTRUCTION HEIGHT AT "0" POINT:

STANDARD

OTHER:

MEASURE AND GIVE DEVIATIONS (A BLANK FIELD MEANS NO DEVIATION)

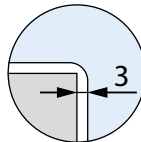
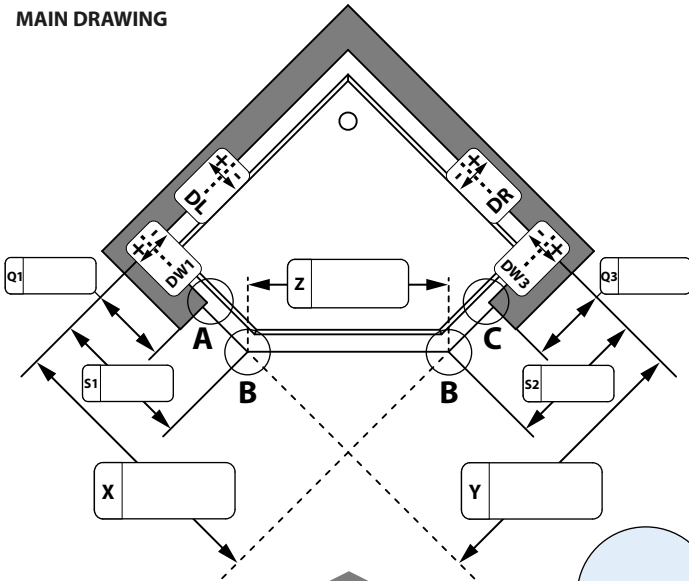
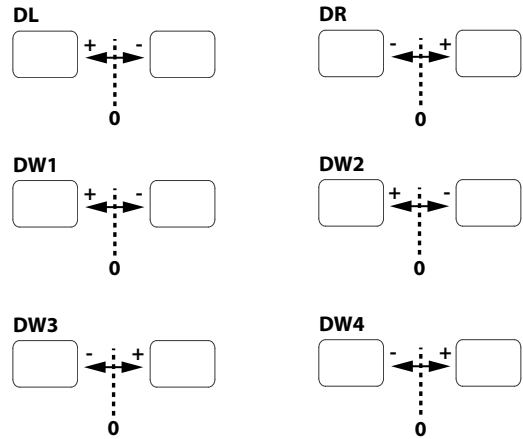

DETAIL D

CHOOSE THE VARIANT OF THE LAYOUT OF THE BUILDING WALLS FOR X AND Y:

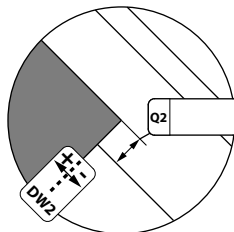
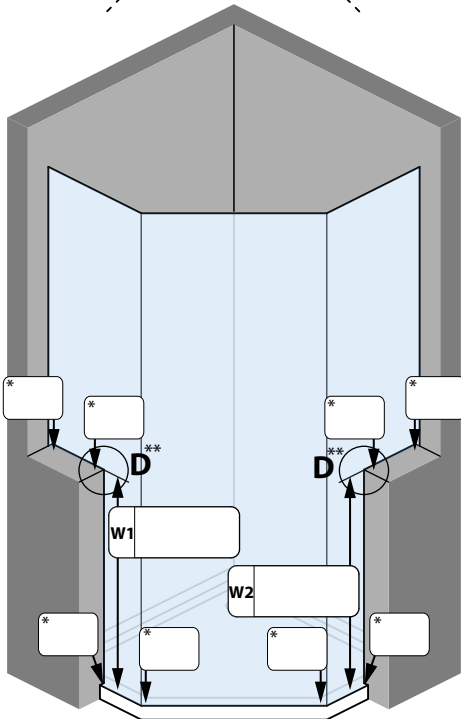
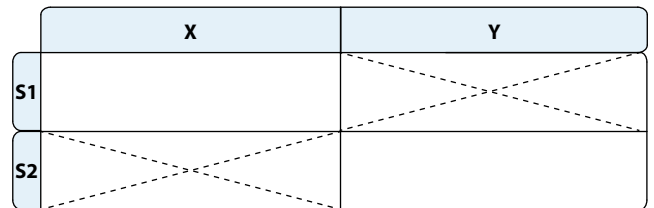

DETAIL A

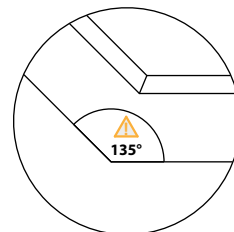

DETAIL B

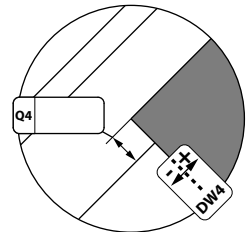

DETAIL C

* INDICATE "0" POINT(S) AND SEPCIFY DEVIATION(S) AS A NEGATIVE VALUE
 POINT(S) "0" IS/ARE THE HIGHEST POINT(S) ON THE FLOOR / SHOWER TRAY / L-SHAPE WALL
 ** CHECK THE FLATNESS AND DESCRIBE ANY CURVES. STANDARD GAP IS 3 MM, CONSIDER INCREASING IT.

 ATTENTION, RADAWAY, FOR TECHNOLOGICAL REASONS, RESERVES THE POSSIBILITY OF MAKING CONSTRUCTION CHANGES.

REMARKS: _____